

SPECIFICATIONS

DIAMETER:	10" (254.0 mm)
SENSITIVITY (2.83 V @ 1 m):	89 dB
POWER HANDLING:	300 W _{RMS} (1,200 W _{PEAK})
FREQUENCY RESPONSE:	25 ~ 500 Hz
NOMINAL IMPEDANCE:	2 OHMS
VOICE-COIL DIAMETER:	3.0" (76.2 mm)

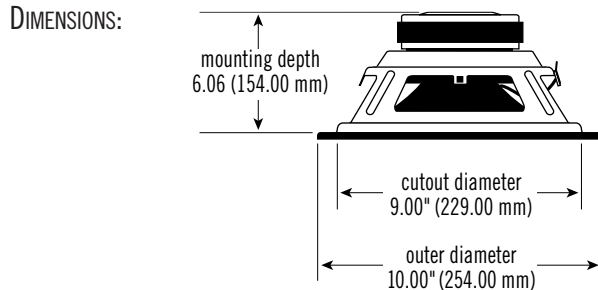

THIELE-SMALL PARAMETERS

VOICE COIL DC RESISTANCE:	R_{EVC} (OHMS)	1.94
VOICE COIL INDUCTANCE @ 1 kHz:	L_{EVC} (MH)	0.17
DRIVER RADIATING AREA:	S_D (IN ²)	48.67
	S_D (CM ²)	314.00
MOTOR FORCE FACTOR:	BL (TM)	8.58
COMPLIANCE VOLUME:	V_{AS} (FT ³)	1.39
	V_{AS} (LITERS)	39.29
SUSPENSION COMPLIANCE:	C_{MS} (µM/N)	280.62
MOVING MASS, AIR LOAD:	M_{MS} (GRAMS)	106.46
MOVING MASS, DIAPHRAGM:	M_{MD} (GRAMS)	103.26
FREE-AIR RESONANCE:	F_S (HZ)	29.12
MECHANICAL Q:	Q_{MS}	5.93
ELECTRICAL Q:	Q_{ES}	0.51
TOTAL Q:	Q_{TS}	0.47
MAGNETIC-GAP HEIGHT:	H_{AG} (IN)	0.39
	H_{AG} (MM)	10.00
VOICE-COIL HEIGHT:	H_{VC} (IN)	1.28
	H_{VC} (MM)	32.50
MAXIMUM EXCURSION:	X_{MAX} (IN)	0.44
	X_{MAX} (MM)	11.25

SEALED BOX VOLUME (INCLUDES DRIVER DISPLACEMENT)

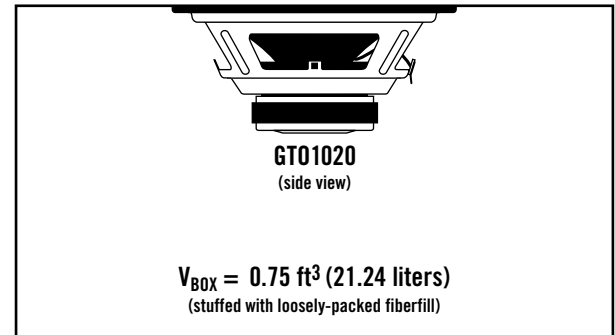

SEALED FREQUENCY RESPONSE @ 2.83 V

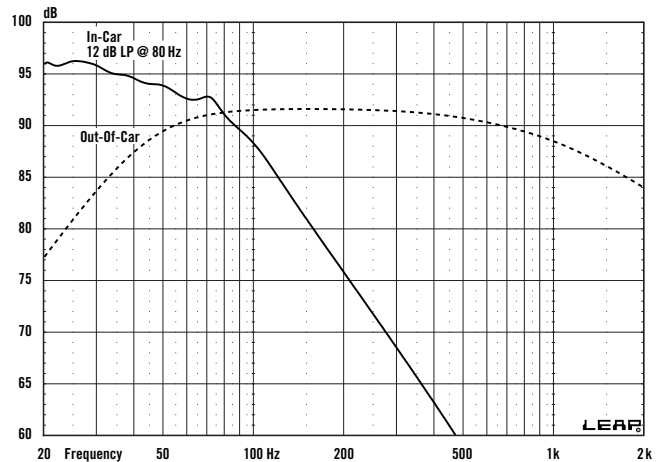

SEALED TRANSDUCER EXCURSION @ 300 W

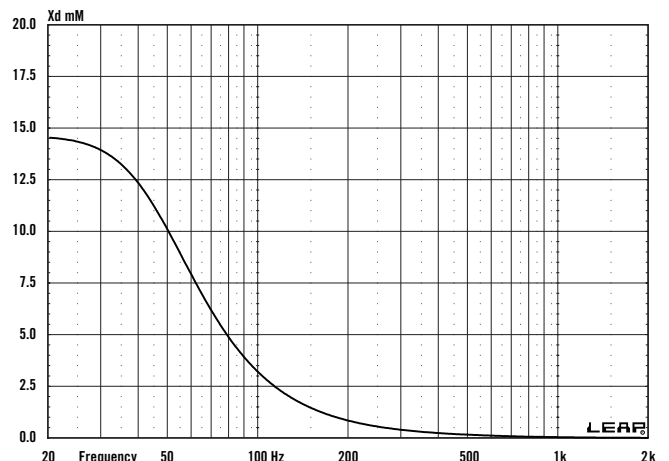



GT01020 10" Woofer – Technical Data

VENTED BOX VOLUME (INCLUDES DRIVER/PORT DISPLACEMENTS)

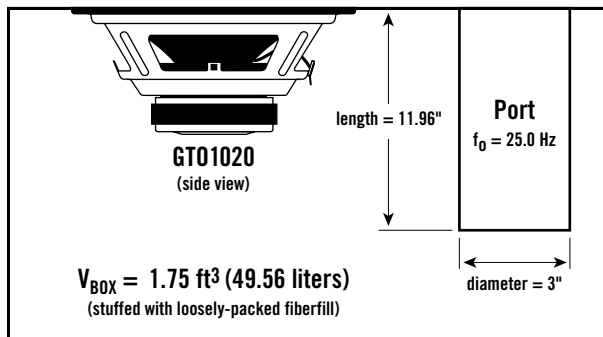

SEALED BANDPASS BOX VOLUME (INCLUDES DRIVER/PORT DISPLACEMENTS)

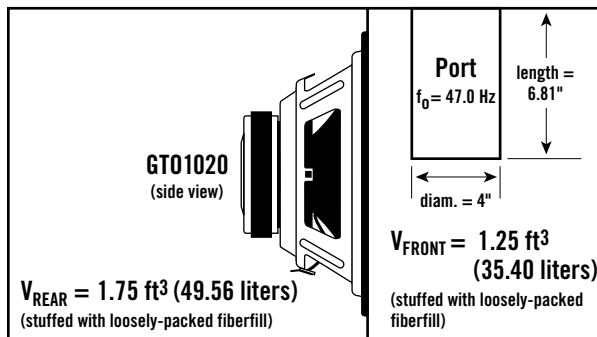

VENTED FREQUENCY RESPONSE @ 2.83 V

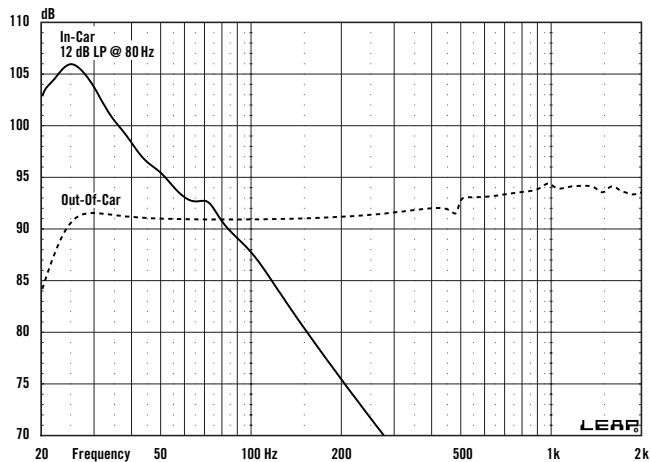

SEALED BANDPASS FREQUENCY RESPONSE @ 2.83 V

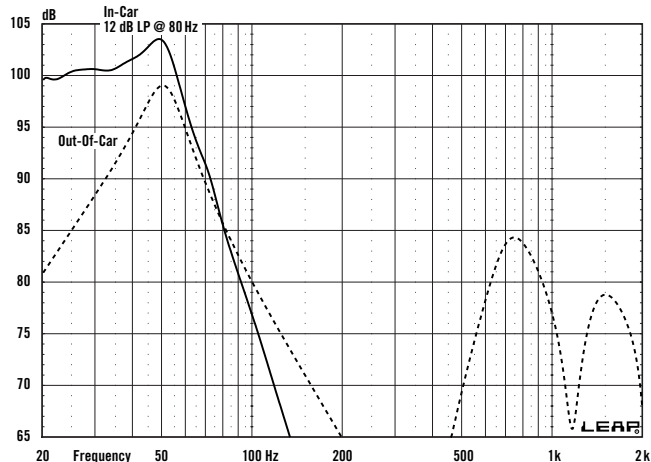

VENTED TRANSDUCER EXCURSION @ 300 W

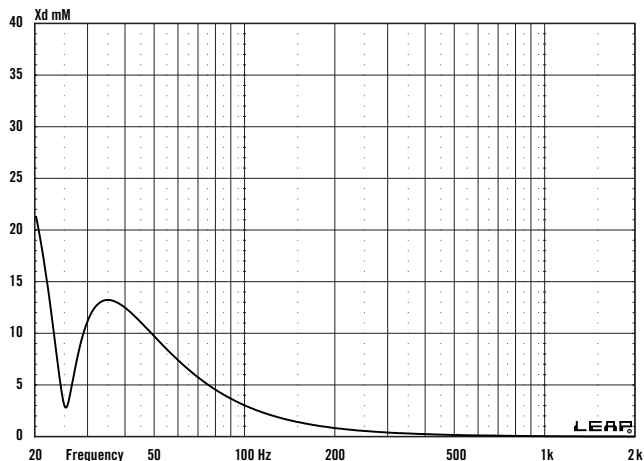

SEALED BANDPASS TRANSDUCER EXCURSION @ 300 W

